

XR2206 Function Generator Assembly & Operations Manual

By Steven Vagts

Z-100 LifeLine
Insert, Issue #132

XR2206 Function Generator Description:

As I described back in issue #130 of the Z-100 LifeLine, test equipment can be quite expensive pieces of hardware, especially for hobbyists or beginners. But fortunately, there are some really cheap Do It Yourself (DIY) kits from China that are available for less than \$10-20.00 on Ebay.

One such kit is the XR2206 Function Generator Kit. The kit does not require a lot of soldering experience, so it makes a great learning project in soldering and kit assembly, while also providing a great addition to the electronics workshop. It uses only through-hole components. Nevertheless, a soldering iron with a needle point tip would be very helpful here. Additionally, there are silk-screened labels on the circuit board that show you where each component should be placed.

The XR2206 Function Generator can generate three types of stable wave forms (sine, triangular, and square wave) with a frequency range from 1Hz to 1MHz and an adjustable amplitude. It uses an AC/DC power adapter (9-12Vdc, 30mA of current).

Please note, this item ships from an international seller. Expected delivery is 10-15 days.

XR2206 Function Generator Features:

- * Based on the XR2206 chip.
- * Small Size: Finished case measures 2.19" wide x 2.81" long x 1.3" high
- * Adjustable Frequency Range: 1 Hz to 1 MHz.
- * Generates three waveforms:
 - Sine Wave:
 - + Adjustable Amplitude: 0-3Vdc at 9Vdc input
 - + Distortion: Less than 1% (at 1KHz)
 - + Flatness: +0.05db 1Hz - 100KHz
 - Triangle Wave:
 - + Adjustable Amplitude: 0-3Vdc at 9Vdc input
 - + Linearity: Less than 1% (up to 100KHz) 10mA
 - Square Wave:
 - + Amplitude: 8V (no load) at 9Vdc input
 - + Rise/Fall Time: Less than 50ns/30ns (at 1KHz)
 - + Symmetry: Less than 5% (at 1KHz)
- * An easy to construct acrylic case is included.
- * Power Supply Required: 9-12Vdc (not included)

Caution: At voltages greater than 12Vdc, the output waveform becomes unstable.

Physical Layout of the XR2206 Function Generator:

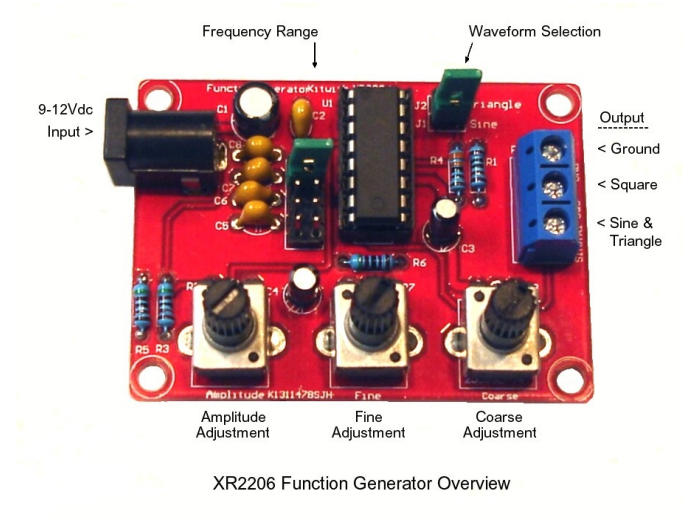

Power:

The XR2206 Function Generator requires power from an external 5-9Vdc AC/DC power supply or a 9V battery with modified cable adapter to connect to the 2.1mm x 5.5mm power jack. There is no ON/OFF switch. When power is applied, the unit is ON.

Controls:

The Function Generator uses three adjustment potentiometers:

- * Amplitude Adjustment
- * Fine Frequency Adjustment
- * Coarse Frequency Adjustment

Assembly:

Note: For a full, more detailed article on the assembly of the XR2206 Function Generator, please check out the website:

<https://www.makeradvisor.com/xr2206-function-generator-diy-kit-review>

It was created with the novice in mind, with plenty of photographs.

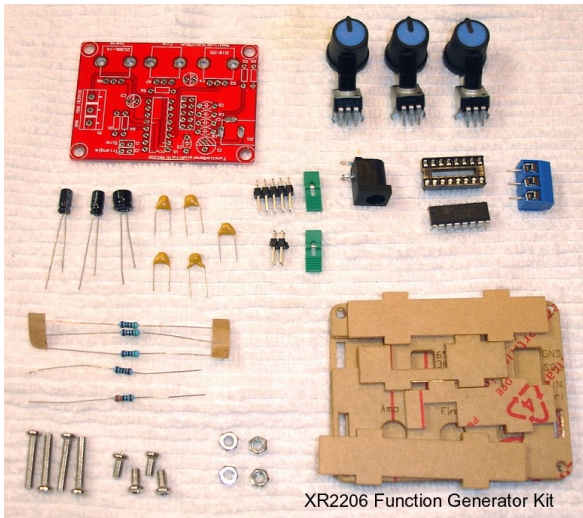

The following description is provided here in the event that the website mentioned above is removed or becomes unavailable. This description also assumes a more experienced hobbyist and will provide more of a summary of procedures, with some details and hints that I found were omitted during my construction.

All the parts needed to construct the Tester are provided, with a two page, nearly unreadable instruction sheet. This manual will guide you through the rather simple construction and operation of this Generator.

A schematic is included at the end.

Assembly will require the following tools:

- Ohmmeter and Capacitor Checker (recommended)
- Needle tip soldering iron or gun
- Thin electronics solder w/flux core
- Fine solder wick or desoldering braid for mistakes
- Needle nose pliers
- Diagonal side cutters
- Phillip's head screwdriver
- 5-9Vdc AC/DC power adapter or 9Vdc battery

Before beginning construction, identify and compare the parts you received with the following list. I also suggest that you check those parts that you can with an ohm-meter and capacitor checker, if they are available. All parts are new; however, in the two frequency counter kits that I have constructed, I found I was missing a 3-pin header and had an extra push button switch. In the other China kits that I have constructed so far, I also found a shorted capacitor and a resistor included in one kit of the wrong value. A little extra time here to check components now, will save considerable time trying to troubleshoot a malfunctioning assembly.

Parts List: (Numbers in parentheses show component markings)

ID:	Component Description:	Number:
R4	330 ohm, 1/4W, 1%, Metal Film Resistor	1 []
R1	1K ohm, 1/4W, 1%, Metal Film Resistor	1 []
R3,R5,R6	5.1K ohm, 1/4W, 1%, Metal Film Resistor	3 []
R2,R7	50K ohm (B503), Adjustable Potentiometer	2 []
R8	100K ohm (B104), Adjustable Potentiometer	1 []
C8	100pF, 20%, (101), Ceramic Capacitor	1 []
C7	2200pF, 20%, (222), Ceramic Capacitor	1 []
C6	0.047uF, 20%, (473), Ceramic Capacitor	1 []
C2	0.1uF, 20%, (104), Ceramic Capacitor	1 []
C5	1.0uF, 20%, (105), Ceramic Capacitor	1 []
C3,C4	10uF, 20%, Aluminum Electrolytic Capacitor	2 []
C1	100uF, 20%, Aluminum Electrolytic Capacitor	1 []
U1	XR2206, Integrated Circuit	1 []
JK1	DC Jack, 2.1mm (ID) x 5.5mm (OD)	1 []
J1,J2	Jumper cap, 2-pin, XM2.54	2 []
P1	Connector Block, 3-pin, screw type	1 []
	Main Circuit Board, 3" x 2.4"	1 []
	10-pin double Header	1 []
	4-pin double Header	1 []
	Acrylic Case Parts	6 []
	Machine Screws, 3mm x 15.8mm	4 []
	Machine Screws, 3mm x 6.35mm	4 []
	Nuts, 2mm	4 []

Assembly Procedures:

Begin assembly by inspecting the bare board.

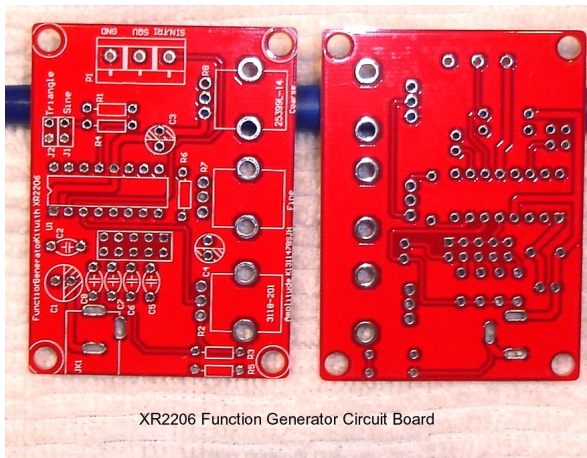

Get a feel for the layout of the parts, part numbers, and what is going to go where. The component side is the side with the silk screening, and while there may be some silk screening on the solder side, for our small kits, all the parts will be installed on the component side of the circuit board (left board in the picture).

Hint: I always suggest installing those components with the lowest vertical profile first. This keeps the circuit board flat and stable for as long as possible during the assembly and soldering process. So, I usually start with any surface mounted components, while the board is empty and most stable. This kit does not have any.

Hint: Using a spare cotton towel under the circuit board helps protect the work surface and stabilize the board during soldering.

Hint: All the solder pins on this board are adequately separated, however, if you accidentally create a solder bridge across 2 or 3 pins, place solder wick over the solder bridge and carefully heat the wick only until solder flows into the wick. Take care not to overheat the component!

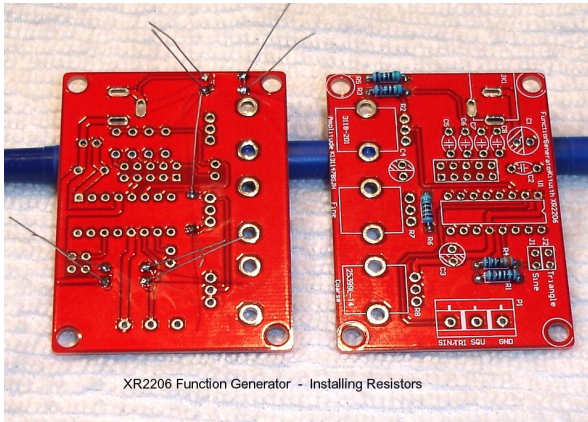

As this kit has no surface mounted components, begin with installation of the resistors. You may install them one at a time, but I suggest inserting all the resistors, bending the leads slightly to keep them in place. Then turn the board over and solder all the leads at once, clipping off the excess leads as you go.

For a small project such as this, the group method also ensures that all of the resistors are of the correct value, used correctly and in their proper location, BEFORE soldering any in place!

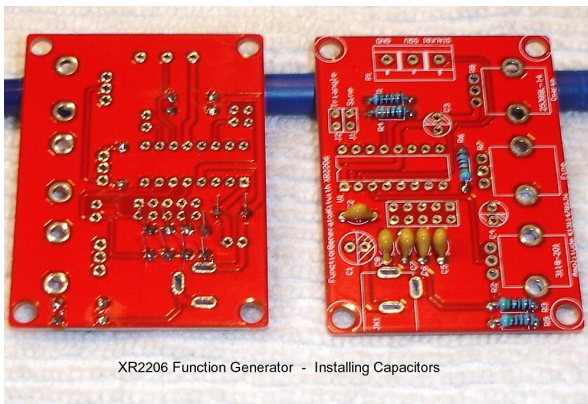

Next, install the ceramic capacitors (next in the height profile) and use the same techniques we used for the resistors - inserting them all, bending the leads to ensure they stay in place, then soldering and clipping the leads at one time, if you desire.

Next, install the IC socket.

Hint: When you install multi-pin components, such as the 16-pin IC socket, always solder one lead at each end of the component first, check to insure the component is fully inserted in the board (not tilted to one side or one end is not fully seated), before soldering the remaining pins. It is much easier to fix a tilted socket with only one pin to heat to reposition the socket.

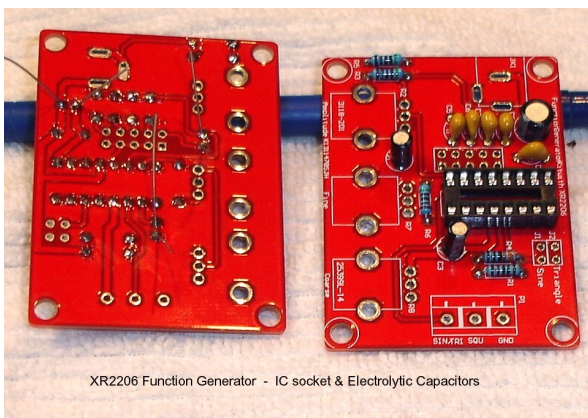

When installing the 16-pin IC socket, watch for the half-moon notch on one end! Install the socket so that this notch is over the similar notch symbol on the silk-screened circuit board. Do **not** install the IC until after the rest of the components have been installed and the solder side of the board has been inspected and cleaned.

Install the electrolytic capacitors and any transistors (there are no transistors in this kit).

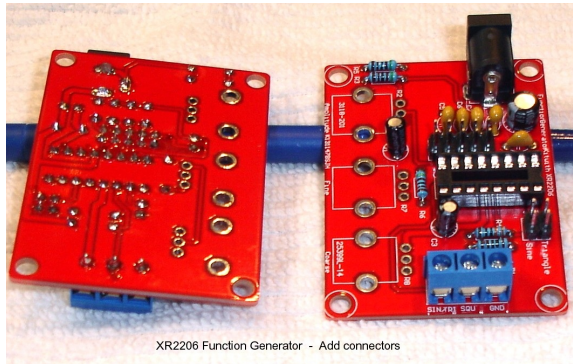

XR2206 Function Generator - Add connectors

The next parts (in height profile) are the DC jack at position JK1, the 3-pin screw-type connector terminal at position P1 and the 10-pin and 4-pin headers.

We have only the potentiometers left to install and we leave them to last to avoid damage during cleaning.

It is time to visually check your work looking for solder bridges, parts with cold solder joints (meaning a poor connection; not having the same appearance of smooth solder flow as the other solder joints), or open, unsoldered joints.

If you have an ohmmeter, check joints near each other for shorts.

Next, clean the solder side of the board. Many use a special flux cleaner product to clean the soldering side. Personally, I check each solder connection and use a fine screwdriver or dental pick to scrape away any flux residue, then use a damp toothbrush to remove the scraped residue.

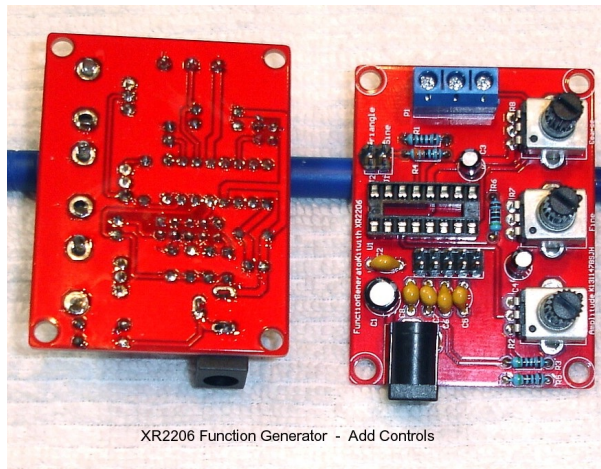

XR2206 Function Generator - Add Controls

When you are satisfied that the board is as good as you can make it, it is time to install the three adjustable potentiometers. Double check the values stamped on the sides of each unit and place in their respective holes.

Install the integrated circuit, look for a dot or notch to indicate where pin 1 is located. Watch that you do not bend any pins under as you carefully insert the IC into its socket (see Hint, next).

Hint: IC's generally come with their pins spread apart just a little further than the width of the IC socket. You can carefully bend these pins closer together by placing the IC on its side on the work table, and gently pressing the pins toward the center of the IC by rotating the IC just slightly. Do the same with the other side.

Leave the knobs until testing is completed and you are ready to assemble the case.

Congratulate yourself on a fine job!

Operation:

Operation is simple. There is no ON/OFF switch. Plug in the 5-9Vdc power supply or a 9v battery with a cable adapter and the device turns ON.

The frequency generator comes with three knobs. One for amplitude adjustment, and other two for fine and coarse frequency adjustment. There's a jumper cap you use to select a frequency range. The other jumper cap should be placed to select one of the three waveforms for the output.

To test the function generator, apply a 9 to 12V power supply. You will need an oscilloscope to test this kit, such as the low-cost DSO138 digital oscilloscope, which will be reviewed in another, future issue. This following pictures are from my Z-100 Heathkit Digital Scope.

Here are the sinusoidal (left), triangular (right), and square wave signals.

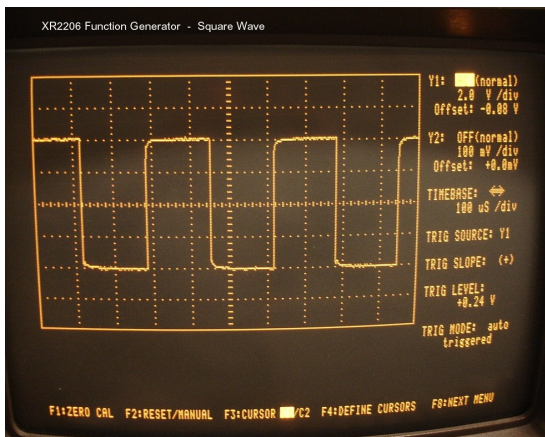
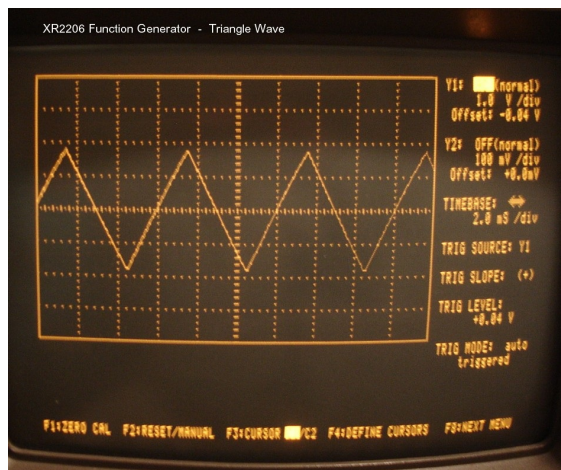
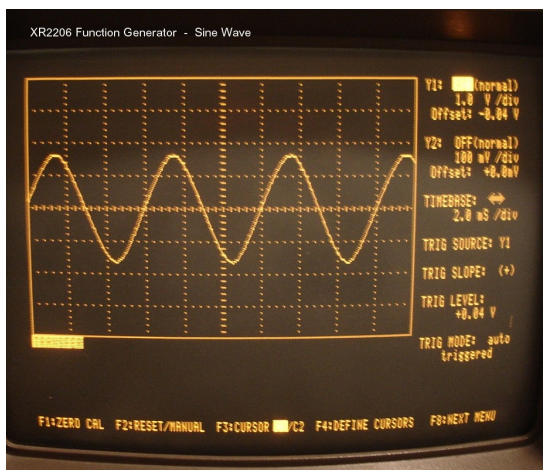

The function generator performed quite well producing very stable sinusoidal, triangular and square wave signals. When testing the kit, we have noticed that the leading edge of the square wave was slightly rounded (possibly due to the length of the input cable).

Theory of Operation:

The heart of this circuit is the integrated circuit XR-2206, which has a structure consisting of three main parts.

1. Voltage Control Oscillator (VCO) that has a frequency that depends upon the value of the capacitor between pin 5-6 and the resistor between the pin 7-8. The output is a synchronous signal or a square wave signal. The synchronous signal is supplied to the management waveform circuit.
2. The Management Waveform Circuit permits having a sinusoidal waveform or a triangular waveform as required by changing the resistance of the legs 13-14.
3. The Buffer Circuit is responsible for managing the output impedance of the circuit at low values, and for the extension to other circuits as well.

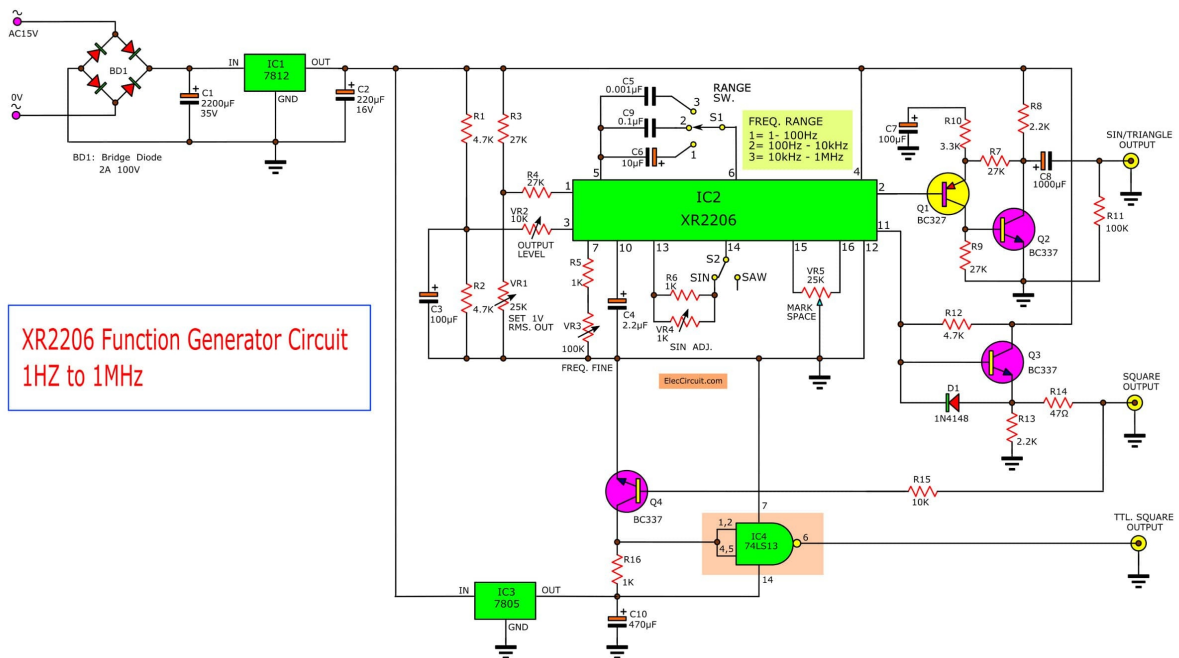

From the generic XR2206 function generator circuit shown, it can be seen that switch S1 selects the frequency range by selecting the capacitance value between pins 5-6:

- * 1-100 Hz
- * 100-10,000 Hz
- * 10,000-1,000,000 Hz

Adjust the frequency desired by changing the value achieved by the VR3.

Next, VR2 is used to adjust the gain ratio of the circuit by the fine control, VR1, to get the maximum output 1V. Then VR5 is adjusted to balance the waveform.

Switch SW2 is selects the signal output of a sine wave or sawtooth waveform.

The signal output is entered through the buffer circuit Q1 and Q2 to C9.

For the square wave signal, output will be out to pin 11 of IC2, and then to the transistor buffer circuit for output at the emitter pin. The square wave signal will have a signal strength of about 12 volts peak to peak, depending upon the input voltage. So if you want to use TTL circuits using a 5Vdc voltage, you must add a DC converter circuit with IC-SN74LS00.

How to Use a Function Generator

A function generator is generally used for testing the response of circuits to common input signals. The function generator produces a variety of voltage patterns at different frequencies and amplitudes. You connect the function generator's electrical leads to the ground and the signal input terminals of the device under test (DUT).

Function Generator Controls:

* **Amplitude Control:** The Amplitude Control changes the signal strength, which is the voltage difference between the output signal's high and low voltage. Its direct current (DC) offset control changes the signal's average voltage with regard to the ground.

* **Frequency Control:** Frequency Control is used to manipulate the output signal's rate of oscillation, and may have two controls; one to select the frequency range and another to select an exact frequency. This enables the function generator to handle the dramatic variation in frequency scale required for signals.

* **Waveform Select:** This control selects the type of waveform desired. More advanced waveform generators use direct digital synthesis techniques to generate any waveform and, in addition to the three basic waveforms of ours, often include waveforms like ramp, noise, and pulse as well as specialized waveforms.

* **Duty Cycle:** The Duty Cycle is its ratio of high to low voltage time, as it concerns square wave signals. The XR2206 does not include this.

You use a function generator by powering it on and configuring the output signal to your intended shape. This will require connecting the ground and signal leads to an oscilloscope to check the controls. You adjust the function generator until you get the appropriate signal and attach the function generator's ground and signal leads to the device under test's input and ground terminals.

To see our Function Generator in action, we need our XR2206 Function Generator, an oscilloscope and a device or circuit that you wish to test. For my testing I used three of my kits - the XR2206 Function Generator, the DSO138 Oscilloscope, and the DL4YHF2 Frequency Counter, as pictured:

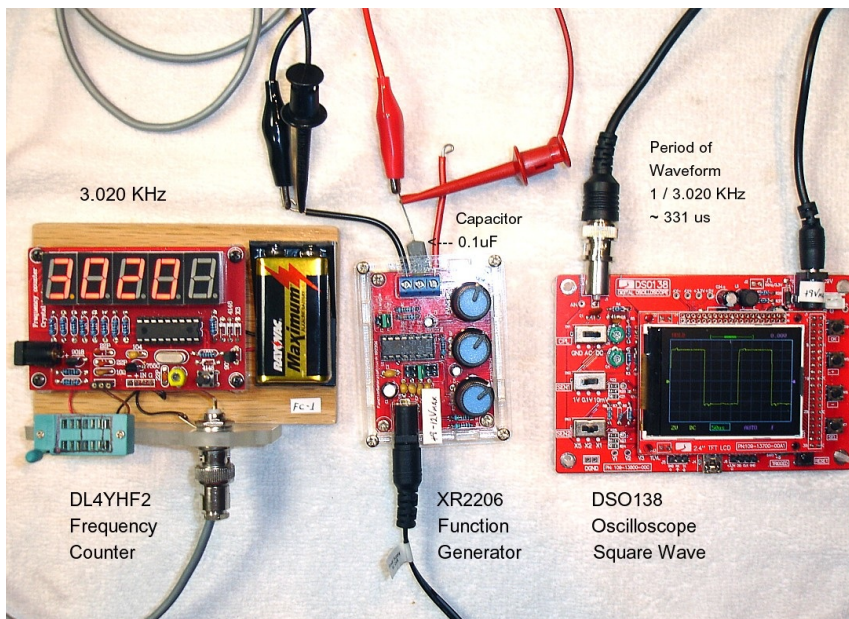

Just power ON the generator and select the desired output signal: square wave, sine wave or triangle wave.

Connect the output leads to an oscilloscope to visualize the output signal and set its parameters using the amplitude and frequency controls.

Attach the output leads of the function generator to the input of the circuit you wish to test - in this case, the frequency counter.

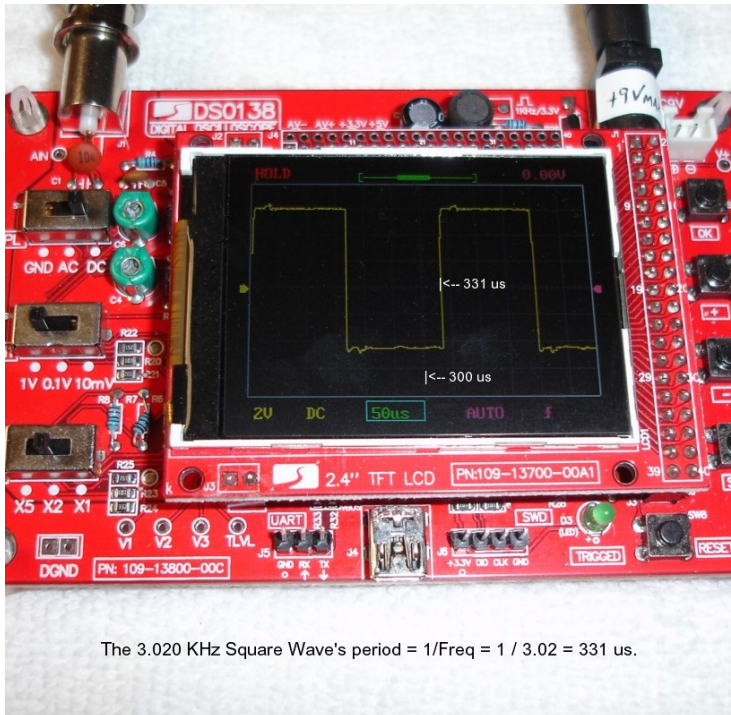

The 3.020 KHz Square Wave's period = $1/\text{Freq} = 1 / 3.02 = 331 \text{ us}$.

In the closeup on the left, you can see the waveform and the frequency on the frequency counter match nicely.

For more information on the other kits in the picture, please refer to their respective articles on my website:

z100lifeline.swagts.com

Please note the 0.1uF capacitor on the output of the XR2206 Function Generator. When I first put this circuit together, I was very disappointed with the DL4YHF2 Frequency Counter. While the oscilloscope showed that the waveform was nicely square and stable, the frequency counter would not stabilize, if I got any frequency at all! Yet, when I used the frequency counter to test an oscillator, it was nicely stable at the correct value.

Looking at the circuit diagram for the DL4YHF Frequency Counter, I saw that the circuit for the crystal & oscillator tester used a 0.1 uF capacitor to eliminate any unwanted DC voltage. But for the input of external frequencies, a capacitor was not included. Perhaps a cyclic DC voltage was confusing the counter?

So, on a whim, I included a 0.1 uF (104K) capacitor (type is not critical) at the output of the generator.

The capacitor fixed the unstable counter, as you can see - a nice solid 3.020 KHz display, but I found that at the much higher frequencies, the waveform was distorted by the charging and discharging capacitor.

I moved the 0.1 uF capacitor to the input of the frequency counter, between the input jack and the circuit board, and now all the test equipment were happy. I have included the new capacitor in an update to the DL4YHF2 Frequency Counter article.

Final Assembly:

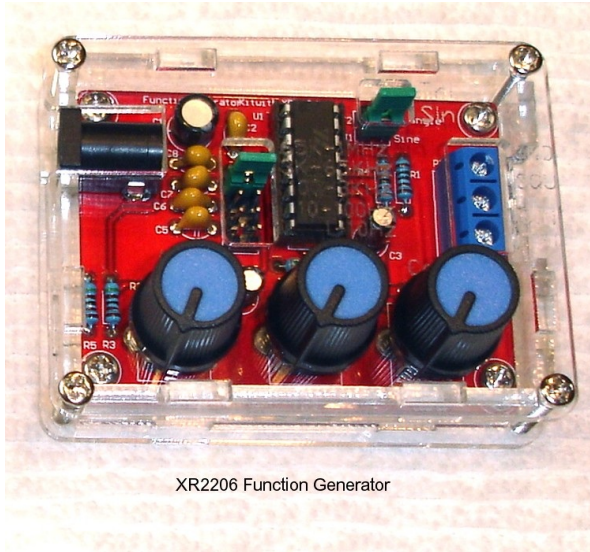

With testing complete, remove the paper cover from the case pieces and assemble the acrylic case using the hardware provided.

The smaller screws and nuts are only used on the circuit board to provide a spacer for the bottom of the circuit board. Trim off any lengths of wire that are too long and interfere with the circuit board sitting flat on the bottom cover.

Place the four sides in the slots of the bottom cover, insuring that the short sides are correctly installed and not blocking the access to the power jack and terminal block.

Use the longer screws to attach the cover to the base while trapping the side pieces between the covers. The holes of the bottom cover are threaded, so no nuts are required.

Conclusions:

This is a simple circuit giving excellent performance given its price. For less than \$15 dollars you can get a function generator with amplitude and frequency adjustment.

The XR2206 function generator DIY kit is great for electronics hobbyists for repairing and debugging circuits, and for learning purposes. The kit comes with through-hole components, and it is easy to solder and assemble. You can have it built in approximately half an hour. While it could never provide the functions of a high-end function generator, for most purposes of a hobbyist, it is an excellent product.

To take full advantage of this unit, you should also invest in a reasonably priced oscilloscope kit, such as the DS0138 and DS0150, which will be reviewed in future issues of the "Z-100 LifeLine".

Enjoy.

If you have any questions or suggestions, please contact me at:
z100lifeline@swvaqts.com

XR2206 Function Generator

